

Membrane air dryers MS-LDM1, MS series



Membrane air dryers MS-LDM1, MS series

FESTO

Product range overview – MS series service units

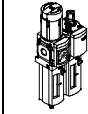
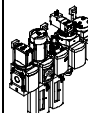
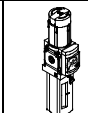
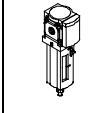
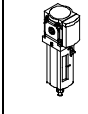
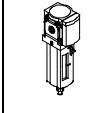
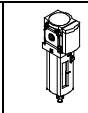
Type	Size	Pneumatic connection in housing	Connecting plate	Pressure regulation range [bar]						Grade of filtration [µm]			
				0.05 ...	0.05 ...	0.1 ...	0.3 ...	0.1 ...	0.5 ...	0.01	1	5	40
Code			AG...	D2	D4	D5	D6	D7	D8	A	B	C	E
Service units													
MSB-FRC 	4	G1/8, G1/4	G1/8, G1/4, G3/8	-	-	-	■	■	-	-	-	■	■
	6	G1/4, G3/8, G1/2	G1/4, G3/8, G1/2, G3/4	-	-	-	■	■	-	-	-	■	■
	9	-	-	-	-	-	-	-	-	-	-	-	-
	12	-	-	-	-	-	-	-	-	-	-	-	-
Service unit combinations (further variants can be ordered using the configurator → Internet: msb4, msb6 or msb9)													
MSB 	4	G1/4	G1/8, G1/4, G3/8	-	-	-	■	■	-	-	-	■	■
	6	G1/2	G1/4, G3/8, G1/2, G3/4	-	-	-	■	■	-	-	-	■	■
	9	-	-	-	-	-	-	-	-	-	-	-	-
	12	-	-	-	-	-	-	-	-	-	-	-	-
Individual devices													
Filter regulators MS-LFR 	4	G1/8, G1/4	G1/8, G1/4, G3/8	-	-	■	■	■	-	-	-	■	■
	6	G1/4, G3/8, G1/2	G1/4, G3/8, G1/2, G3/4	-	-	■	■	■	■	-	-	■	■
	9	G3/4, G1	G1/2, G3/4, G1, G1 1/4, G1 1/2	-	-	■	■	■	■	-	-	■	■
	12	-	G1, G1 1/4, G1 1/2, G2	-	-	-	■	■	■	-	-	■	■
Filters MS-LF 	4	G1/8, G1/4	G1/8, G1/4, G3/8	-	-	-	-	-	-	-	-	■	■
	6	G1/4, G3/8, G1/2	G1/4, G3/8, G1/2, G3/4	-	-	-	-	-	-	-	-	■	■
	9	G3/4, G1	G1/2, G3/4, G1, G1 1/4, G1 1/2	-	-	-	-	-	-	-	-	■	■
	12	-	G1, G1 1/4, G1 1/2, G2	-	-	-	-	-	-	-	-	■	■
Fine and micro filters MS-LFM 	4	G1/8, G1/4	G1/8, G1/4, G3/8	-	-	-	-	-	-	■	■	-	-
	6	G1/4, G3/8, G1/2	G1/4, G3/8, G1/2, G3/4	-	-	-	-	-	-	■	■	-	-
	9	G3/4, G1	G1/2, G3/4, G1, G1 1/4, G1 1/2	-	-	-	-	-	-	■	■	-	-
	12	-	G1, G1 1/4, G1 1/2, G2	-	-	-	-	-	-	■	■	-	-
Activated carbon filters MS-LFX 	4	G1/8, G1/4	G1/8, G1/4, G3/8	-	-	-	-	-	-	-	-	-	-
	6	G1/4, G3/8, G1/2	G1/4, G3/8, G1/2, G3/4	-	-	-	-	-	-	-	-	-	-
	9	G3/4, G1	G1/2, G3/4, G1, G1 1/4, G1 1/2	-	-	-	-	-	-	-	-	-	-
	12	-	G1, G1 1/4, G1 1/2, G2	-	-	-	-	-	-	-	-	-	-
Water separators MS-LWS 	4	-	-	-	-	-	-	-	-	-	-	-	-
	6	G1/4, G3/8, G1/2	G1/4, G3/8, G1/2, G3/4	-	-	-	-	-	-	-	-	-	-
	9	G3/4, G1	G1/2, G3/4, G1, G1 1/4, G1 1/2	-	-	-	-	-	-	-	-	-	-
	12	-	G1, G1 1/4, G1 1/2, G2	-	-	-	-	-	-	-	-	-	-

Membrane air dryers MS-LDM1, MS series

Product range overview – MS series service units

Type	Size	Bowl guard		Condensate drains			Pressure indicator					Security		Options		→ Page/ Internet	
		Plastic bowl with plastic bowl guard	Metal bowl	Manual rotary	Semi-automatic	Fully automatic	External, fully automatic, electrical	Cover plate (without pressure gauge)	Integrated MS pressure gauge	Adapter plate for EN pressure gauge G1/8	Adapter plate for EN pressure gauge G1/4	Pressure sensor	Rotary knob with detent, lockable via accessories	Rotary knob with integrated lock	Silencer		Flow direction from right to left
Code		R	U	M	H	V	E...	VS	AG	A8	A4	AD...	AS	E11	S	Z	
Service units																	
MSB-FRC	4	■	-	■	-	■	-	-	■	-	-	-	■	-	-	■	msb4
	6	■	■	■	-	■	-	-	■	-	-	-	■	-	-	■	msb6
	9	-	-	-	-	-	-	-	-	-	-	-	-	-	-	-	-
	12	-	-	-	-	-	-	-	-	-	-	-	-	-	-	-	-
Service unit combinations																	
MSB	4	■	■	■	-	■	-	-	■	-	-	-	■	-	-	■	msb4
	6	■	■	■	-	■	-	-	■	-	-	-	■	-	-	■	msb6
	9	-	-	-	-	-	-	-	-	-	-	-	-	-	-	-	-
	12	-	-	-	-	-	-	-	-	-	-	-	-	-	-	-	-
Individual devices																	
Filter regulators MS-LFR	4	■	■	■	■	■	-	■	■	■	■	■	■	■	-	■	ms4-lfr
	6	■	■	■	■	■	■	■	■	■	■	■	■	■	-	■	ms6-lfr
	9	-	■	■	■	■	■	■	■	■	■	■	■	■	-	■	ms9-lfr
	12	-	■	■	-	■	■	■	■	■	■	■	■	■	-	■	ms12-lfr
Filters MS-LF	4	■	■	■	■	■	-	-	-	-	-	-	-	-	-	■	ms4-lf
	6	■	■	■	■	■	■	-	-	-	-	-	-	-	-	■	ms6-lf
	9	-	■	■	■	■	■	-	-	-	-	-	-	-	-	■	ms9-lf
	12	-	■	■	-	■	■	-	-	-	-	-	-	-	-	■	ms12-lf
Fine and micro filters MS-LFM	4	■	■	■	■	■	-	-	-	-	-	-	-	-	-	■	ms4-lfm
	6	■	■	■	■	■	■	-	-	-	-	-	-	-	-	■	ms6-lfm
	9	-	■	■	■	■	■	-	-	-	-	-	-	-	-	■	ms9-lfm
	12	-	■	■	-	■	■	-	-	-	-	-	-	-	-	■	ms12-lfm
Activated carbon filters MS-LFX	4	■	■	-	-	-	-	-	-	-	-	-	-	-	-	■	ms4-lfx
	6	■	■	-	-	-	-	-	-	-	-	-	-	-	-	■	ms6-lfx
	9	-	■	-	-	-	-	-	-	-	-	-	-	-	-	■	ms9-lfx
	12	-	■	-	-	-	-	-	-	-	-	-	-	-	-	■	ms12-lfx
Water separators MS-LWS	4	-	-	-	-	-	-	-	-	-	-	-	-	-	-	-	-
	6	-	■	-	-	■	■	-	-	-	-	-	-	-	-	■	ms6-lws
	9	-	■	-	-	■	■	-	-	-	-	-	-	-	-	■	ms9-lws
	12	-	■	-	-	■	■	-	-	-	-	-	-	-	-	■	ms12-lws

Membrane air dryers MS-LDM1, MS series



Product range overview – MS series service units

Type	Size	Pneumatic connection in housing	Connecting plate	Pressure regulation range [bar]							Supply voltage			
				0.05 ... 0.7	0.05 ... 2.5	0.1 ... 4	0.3 ... 7	0.1 ... 12	0.5 ... 16	24 V DC, connection pattern to EN 175301	24 V DC, connection M12 to IEC 61076-2-101	110 V AC, connection pattern to EN 175301	230 V AC, connection pattern to EN 175301	
Code			AG...	D2	D4	D5	D6	D7	D8	V24	V24P	V110	V230	
Individual devices														
Pressure regulators MS-LR		4	G1/8, G1/4	G1/8, G1/4, G3/8	-	-	■	■	■	-	-	-	-	
		6	G1/4, G3/8, G1/2	G1/4, G3/8, G1/2, G3/4	-	-	■	■	■	■	-	-	-	
		9	G3/4, G1	G1/2, G3/4, G1, G1 1/4, G1 1/2	-	-	■	■	■	■	-	-	-	
		12	-	G1, G1 1/4, G1 1/2, G2	-	-	-	■	■	■	-	-	-	
Pressure regulators MS-LRB		4	G1/4	G1/8, G1/4, G3/8	-	-	■	■	■	-	-	-	-	
		6	G1/2	G1/4, G3/8, G1/2, G3/4	-	-	■	■	■	■	-	-	-	
		9	-	-	-	-	-	-	-	-	-	-	-	
		12	-	-	-	-	-	-	-	-	-	-	-	
Precision pressure regulators MS-LRP		4	-	-	-	-	-	-	-	-	-	-	-	
		6	G1/4, G3/8, G1/2	G1/4, G3/8, G1/2, G3/4	■	■	■	-	■	-	-	-	-	
		9	-	-	-	-	-	-	-	-	-	-	-	
		12	-	-	-	-	-	-	-	-	-	-	-	
Precision pressure regulators MS-LRPB		4	-	-	-	-	-	-	-	-	-	-	-	
		6	G1/2	G1/4, G3/8, G1/2, G3/4	■	■	■	-	■	-	-	-	-	
		9	-	-	-	-	-	-	-	-	-	-	-	
		12	-	-	-	-	-	-	-	-	-	-	-	
Electrical pressure regulators MS-LRE		4	-	-	-	-	-	-	-	-	-	-	-	
		6	G1/4, G3/8, G1/2	G1/4, G3/8, G1/2, G3/4	-	-	■	■	■	■	-	-	-	
		9	-	-	-	-	-	-	-	-	-	-	-	
		12	-	-	-	-	-	-	-	-	-	-	-	
Lubricators MS-LOE		4	G1/8, G1/4	G1/8, G1/4, G3/8	-	-	-	-	-	-	-	-	-	
		6	G1/4, G3/8, G1/2	G1/4, G3/8, G1/2, G3/4	-	-	-	-	-	-	-	-	-	
		9	G3/4, G1	G1/2, G3/4, G1, G1 1/4, G1 1/2	-	-	-	-	-	-	-	-	-	
		12	-	G1, G1 1/4, G1 1/2, G2	-	-	-	-	-	-	-	-	-	
On-off valves, manually actuated MS-EM(1)		4	G1/8, G1/4	G1/8, G1/4, G3/8	-	-	-	-	-	-	-	-	-	
		6	G1/4, G3/8, G1/2	G1/4, G3/8, G1/2, G3/4	-	-	-	-	-	-	-	-	-	
		9	G3/4, G1	G1/2, G3/4, G1, G1 1/4, G1 1/2	-	-	-	-	-	-	-	-	-	
		12	-	G1, G1 1/4, G1 1/2, G2	-	-	-	-	-	-	-	-	-	
On-off valves, electrically actuated MS-EE		4	G1/8, G1/4	G1/8, G1/4, G3/8	-	-	-	-	-	■	-	■	■	
		6	G1/4, G3/8, G1/2	G1/4, G3/8, G1/2, G3/4	-	-	-	-	-	■	-	■	■	
		9	G3/4, G1	G1/2, G3/4, G1, G1 1/4, G1 1/2	-	-	-	-	-	■	■	■	■	
		12	-	G1, G1 1/4, G1 1/2, G2	-	-	-	-	-	■	■	■	■	
Soft-start valves, pneumatically actuated MS-DL		4	G1/8, G1/4	G1/8, G1/4, G3/8	-	-	-	-	-	-	-	-	-	
		6	G1/4, G3/8, G1/2	G1/4, G3/8, G1/2, G3/4	-	-	-	-	-	-	-	-	-	
		9	-	-	-	-	-	-	-	-	-	-	-	
		12	-	G1, G1 1/4, G1 1/2, G2	-	-	-	-	-	-	-	-	-	
Soft-start valves, electrically actuated MS-DE		4	G1/8, G1/4	G1/8, G1/4, G3/8	-	-	-	-	-	■	-	■	■	
		6	G1/4, G3/8, G1/2	G1/4, G3/8, G1/2, G3/4	-	-	-	-	-	■	-	■	■	
		9	-	-	-	-	-	-	-	-	-	-	-	
		12	-	G1, G1 1/4, G1 1/2, G2	-	-	-	-	-	-	■	■	■	■







Membrane air dryers MS-LDM1, MS series

Product range overview – MS series service units

Type	Size	Bowl guard		Pressure indicator				Security			Options		→ Page/ Internet
		Plastic bowl with plastic bowl guard	Metal bowl	Cover plate (without pressure gauge)	Integrated MS pressure gauge	Adapter plate for EN pressure gauge G1/8	Adapter plate for EN pressure gauge G1/4	Pressure sensor	Rotary knob with detent, lockable via accessories	Rotary knob with integrated lock	Silencer	Flow direction from right to left	
Code		R	U	VS	AG	A8	A4	AD...	AS	E11	S	Z	
Individual devices													
Pressure regulators MS-LR	4	-	-	■	■	■	■	■	■	■	-	■	ms4-lr
	6	-	-	■	■	-	■	■	■	■	-	■	ms6-lr
	9	-	-	■	■	-	■	■	■	■	-	■	ms9-lr
	12	-	-	■	■	-	■	-	■	■	-	■	ms12-lr
Pressure regulators MS-LRB	4	-	-	■	■	■	■	■	■	■	-	■	ms4-lrb
	6	-	-	■	■	-	■	■	■	■	-	■	ms6-lrb
	9	-	-	-	-	-	-	-	-	-	-	-	-
	12	-	-	-	-	-	-	-	-	-	-	-	-
Precision pressure regulators MS-LRP	4	-	-	-	-	-	-	-	-	-	-	-	-
	6	-	-	■	-	■	■	■	■	■	-	■	ms6-lrp
	9	-	-	-	-	-	-	-	-	-	-	-	-
	12	-	-	-	-	-	-	-	-	-	-	-	-
Precision pressure regulators MS-LRPB	4	-	-	-	-	-	-	-	-	-	-	-	-
	6	-	-	■	-	■	■	■	■	■	-	■	ms6-lrpb
	9	-	-	-	-	-	-	-	-	-	-	-	-
	12	-	-	-	-	-	-	-	-	-	-	-	-
Electrical pressure regulators MS-LRE	4	-	-	-	-	-	-	-	-	-	-	-	-
	6	-	-	■	■	-	■	-	-	-	-	■	ms6-lre
	9	-	-	-	-	-	-	-	-	-	-	-	-
	12	-	-	-	-	-	-	-	-	-	-	-	-
Lubricators MS-LOE	4	■	■	-	-	-	-	-	-	-	-	■	ms4-loe
	6	■	■	-	-	-	-	-	-	-	-	■	ms6-loe
	9	-	■	-	-	-	-	-	-	-	-	■	ms9-loe
	12	-	■	-	-	-	-	-	-	-	-	■	ms12-loe
On-off valves, manually actuated MS-EM(1)	4	-	-	■	■	■	■	■	-	-	■	■	ms4-em1
	6	-	-	■	■	-	■	■	-	-	■	■	ms6-em1
	9	-	-	■	■	-	■	-	-	-	■	■	ms9-em
	12	-	-	■	■	-	■	-	-	-	■	■	ms12-em
On-off valves, electrically actuated MS-EE	4	-	-	■	■	■	■	■	-	-	■	■	ms4-ee
	6	-	-	■	■	-	■	■	-	-	■	■	ms6-ee
	9	-	-	■	■	-	■	-	-	-	■	■	ms9-ee
	12	-	-	■	■	-	■	-	-	-	■	■	ms12-ee
Soft-start valves, pneumatically actuated MS-DL	4	-	-	■	■	■	■	■	-	-	-	■	ms4-dl
	6	-	-	■	■	-	■	■	-	-	-	■	ms6-dl
	9	-	-	-	-	-	-	-	-	-	-	-	-
	12	-	-	■	■	-	■	-	-	-	-	■	ms12-dl
Soft-start valves, electrically actuated MS-DE	4	-	-	■	■	■	■	■	-	-	-	■	ms4-de
	6	-	-	■	■	-	■	■	-	-	-	■	ms6-de
	9	-	-	-	-	-	-	-	-	-	-	-	-
	12	-	-	■	■	-	■	-	-	-	-	■	ms12-de

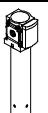
Membrane air dryers MS-LDM1, MS series

Product range overview – MS series service units

Type	Size	Pneumatic connection in housing	Connecting plate	Performance Level		Supply voltage				
				Category 1, 1-channel	Category 4, 2-channel with self-monitoring	24 V DC, connection pattern to EN 175301	24 V DC, connection M12 to IEC 61076-2-101 / to EN 60947-5-2	110 V AC, connection pattern to EN 175301	230 V AC, connection pattern to EN 175301	
Code			AG...	C	E	V24	V24P	V110	V230	
Individual devices										
Soft start and exhaust valves MS-SV-C		4	–							
		6	G $\frac{1}{2}$	G $\frac{1}{4}$, G $\frac{3}{8}$, G $\frac{1}{2}$, G $\frac{3}{4}$	■	–	■	■	■	■
		9	G $\frac{3}{4}$, G1	G $\frac{1}{2}$, G $\frac{3}{4}$, G1, G1 $\frac{1}{4}$, G1 $\frac{1}{2}$	■	–	■	■	■	■
		12	–							
Soft start and exhaust valves MS-SV-E		4	–							
		6	G $\frac{1}{2}$	G $\frac{1}{4}$, G $\frac{3}{8}$, G $\frac{1}{2}$, G $\frac{3}{4}$	–	■	■	–	–	–
		9	–							
		12	–							
Membrane air dryers MS-LDM1		4	G $\frac{1}{8}$, G $\frac{1}{4}$	G $\frac{1}{8}$, G $\frac{1}{4}$, G $\frac{3}{8}$	–	–	–	–	–	–
		6	G $\frac{1}{4}$, G $\frac{3}{8}$, G $\frac{1}{2}$	G $\frac{1}{4}$, G $\frac{3}{8}$, G $\frac{1}{2}$, G $\frac{3}{4}$	–	–	–	–	–	–
		9	–							
		12	–							
Branching modules MS-FRM		4	G $\frac{1}{8}$, G $\frac{1}{4}$	G $\frac{1}{8}$, G $\frac{1}{4}$, G $\frac{3}{8}$	–	–	–	–	–	–
		6	G $\frac{1}{4}$, G $\frac{3}{8}$, G $\frac{1}{2}$	G $\frac{1}{4}$, G $\frac{3}{8}$, G $\frac{1}{2}$, G $\frac{3}{4}$	–	–	–	–	–	–
		9	G $\frac{3}{4}$, G1	G $\frac{1}{2}$, G $\frac{3}{4}$, G1, G1 $\frac{1}{4}$, G1 $\frac{1}{2}$	–	–	–	–	–	–
		12	–	G1, G1 $\frac{1}{4}$, G1 $\frac{1}{2}$, G2	–	–	–	–	–	–
Distributor blocks MS-FRM-FRZ		4	G $\frac{1}{4}$	–	–	–	–	–	–	
		6	G $\frac{1}{2}$	–	–	–	–	–	–	
		9	–							
		12	–							
Flow sensors SFAM		4	–							
		6	G $\frac{1}{2}$	G $\frac{1}{2}$	–	–	–	–	–	–
		9	–	G1, G1 $\frac{1}{2}$	–	–	–	–	–	–
		12	–							

Membrane air dryers MS-LDM1, MS series

Product range overview – MS series service units

Type	Size	Bowl guard		Pressure indicator				Switch output			Options		→ Page/ Internet
		Plastic bowl with plastic bowl guard	Metal bowl	Cover plate (without pressure gauge)	Integrated MS pressure gauge	Adapter plate for EN pressure gauge G1/8	Adapter plate for EN pressure gauge G1/4	Pressure sensor	2x PNP or NPN, 1 analogue output 4 ... 20 mA	2x PNP or NPN, 1 analogue output 0 ... 10 V	Silencer	Flow direction from right to left	
Code		R	U	VS	AG	A8	A4	AD...	2SA	2SV	S	Z/R	
Individual devices													
Soft start and exhaust valves MS-SV-C	4	-											-
	6	-	-	■	■	-	■	■	-	-	■	■	ms6-sv
	9	-	-	■	■	-	■	■	-	-	■	■	ms9-sv
	12	-											-
Soft start and exhaust valves MS-SV-E	4	-											-
	6	-	-	■	■	-	■	■	-	-	■	■	ms6-sv
	9	-											-
	12	-											-
Membrane air dryers MS-LDM1	4	-	■	-	-	-	-	-	-	-	-	■	8
	6	-	■	-	-	-	-	-	-	-	-	■	8
	9	-											-
	12	-											-
Branching modules MS-FRM	4	-	-	■	■	■	■	■	-	-	-	■	ms4-frm
	6	-	-	■	■	-	■	■	-	-	-	■	ms6-frm
	9	-	-	■	■	-	■	■	-	-	-	■	ms9-frm
	12	-	-	■	-	-	-	-	-	-	-	-	ms12-frm
Distributor blocks MS-FRM-FRZ	4	-	-	-	-	-	-	-	-	-	-	■	ms4-frm
	6	-	-	-	-	-	-	-	-	-	-	■	ms6-frm
	9	-											-
	12	-											-
Flow sensors SFAM	4	-											-
	6	-	-	-	-	-	-	-	■	■	-	■	sfam-62
	9	-	-	-	-	-	-	-	■	■	-	■	sfam-90
	12	-											-

Membrane air dryers MS4/MS6-LDM1, MS series

Peripherals overview

Membrane air dryers MS4/MS6-LDM1

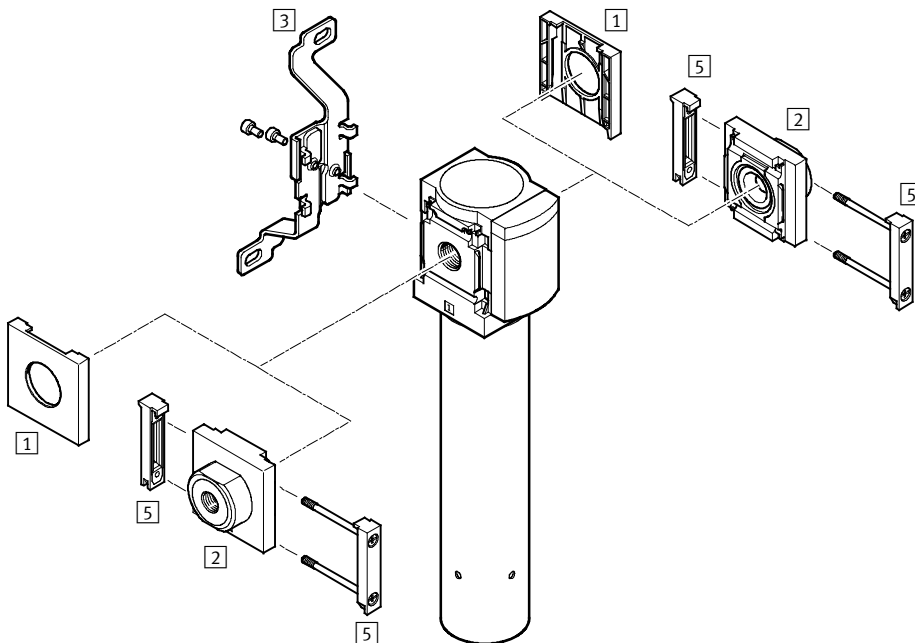

Note

Additional accessories:

- Module connector for combination with sizes MS4/MS6 or size MS9 → Internet: amv, rmv, armv
- Adapter plate for mounting on profiles → Internet: ipm-80, ipm-40-80, ipm-80-80

Mounting attachments and accessories

	Individual unit		Combination		→ Page/Internet
	without connecting plate	with connecting plate	without connecting plate	with connecting plate	
1 Cover cap MS4/6-END	■	–	■	–	ms4-end, ms6-end
2 Connecting plate MS4/6-AG...	–	■	–	■	ms4-ag, ms6-ag
3 Mounting bracket MS4/6-WB	■	■	–	–	ms4-wb, ms6-wb
5 Module connector MS4/6-MV	–	■	■	■	ms4-mv, ms6-mv
– Mounting bracket MS4-WBM	■	■	–	–	ms4-wbm
– Mounting bracket MS4/6-WP/WPB/WPE/WPM	–	■	■	■	ms4-wp, ms6-wp

Membrane air dryers MS4/MS6-LDM1, MS series

FESTO

Type codes

		MS	6	-	LDM1	-	1/2	-	P20
Series									
MS	Standard service unit								
Size									
4	Grid dimension 40 mm								
6	Grid dimension 62 mm								
Service function									
LDM1	Membrane air dryer								
Pneumatic connection									
MS4									
1/8	Female thread G1/8								
1/4	Female thread G1/4								
MS6									
1/4	Female thread G1/4								
3/8	Female thread G3/8								
1/2	Female thread G1/2								
Flow cartridge									
P10	Cartridge P10								
P20	Cartridge P20								
P40	Cartridge P40								

Further variants can be ordered using the modular system → 15

- Connecting plates
- Flow cartridge
- Ducted purging air
- Type of mounting
- UL certification
- Flow direction



Membrane air dryers MS4/MS6-LDM1, MS series

FESTO

Technical data

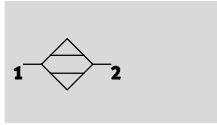
Function



-  - Flow rate
50 ... 400 l/min
-  - Temperature range
+2 ... +50 °C
-  - Operating pressure
3 ... 12.5 bar

Pressure dew point reduction:
20 K



- Optimum final dryer with excellent operational reliability
- Suitable for use as an individual unit or for integration in existing service unit combinations
- Flow rate-dependent dew point reduction

- Wear-free function requiring no external energy
- The composition of the compressed air remains almost unchanged due to the drying process
- 15% purge air flow rate
- Optional purge ring for ducting of purging air

Typical areas of application:

- Drying, cleaning of precision parts
- Measuring technology
- Rinsing of precision glass scales
- Painting systems
- Paper and packaging machines

 Note

Prefiltration of the compressed air using a micro filter MS-LFM-A, grade of filtration 0.01 µm (residual particles < 0.1 µm, residual oil content < 0.1 mg/m³) is vital for flawless functioning of the unit.

General technical data					
Size	MS4		MS6		
Pneumatic connection 1, 2	G1/8	G1/4	G1/4	G3/8	G1/2
Design	Membrane dryer with internal air consumption				
Type of mounting	Via accessories				
	In-line installation				
Assembly position	Vertical ±5°				
Air purity class at the output	Compressed air in accordance with ISO 8573-1:2010 [1:3:2]				

• | - Note: This product conforms to ISO 1179-1 and to ISO 228-1

Standard flow rate q _n ¹⁾ [l/min]					
Size	MS4		MS6		
	Cartridge P05	Cartridge P10	Cartridge P20	Cartridge P30	Cartridge P40
Input q _n In	59	118	235	353	471
Output q _n Out	50	100	200	300	400
Purge air q _n Purge	8.8	17.6	35.3	52.9	70.6

1) Measured at p₁ = 6.9 bar, θ_{pd} In = 25 °C, θ_{pd} Out = 5 °C ± 1.5 °C (θ_{pA} Out = -21.5 °C ± 1.2 °C), θ_{amb} = 25 °C

Membrane air dryers MS4/MS6-LDM1, MS series

FESTO

Technical data

Operating and environmental conditions	
Operating pressure [bar]	3 ... 12.5 (3 ... 10) ¹⁾
Operating medium	Compressed air in accordance with ISO 8573-1:2010 [1:4:2]
Note on operating/pilot medium	Operation with lubricated medium not possible
Pressure dew point reduction [K]	20
Ambient temperature [°C]	+2 ... +50
Temperature of medium [°C]	+2 ... +50
Storage temperature [°C]	-20 ... +60
Corrosion resistance class CRC ²⁾	2
UL certification	cULus recognized (OL)

1) Value in brackets applies to MS4/MS6-LDM1 with UL certification.

2) Corrosion resistance class 2 according to Festo standard 940 070

Components subject to moderate corrosion stress. Externally visible parts with primarily decorative surface requirements which are in direct contact with a normal industrial environment or media such as coolants or lubricating agents.

Weights [g]					
Size	MS4		MS6		
	Cartridge P05	Cartridge P10	Cartridge P20	Cartridge P30	Cartridge P40
Membrane air dryer	420	530	1,050	1,200	1,300

Materials

Sectional view

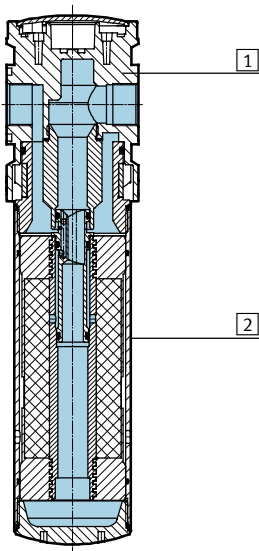

Membrane air dryer		
1	Housing	Die-cast aluminium
2	Bowl	Wrought aluminium alloy
-	Seals	NBR
Note on materials		RoHS-compliant

Membrane air dryers MS4/MS6-LDM1, MS series

Technical data

Pressure dew point t_{pd} (output) as a function of the standard flow rate at output q_n ¹⁾

MS4-LDM1-...-P05

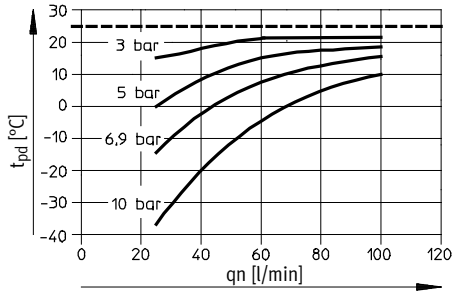

MS4-LDM1-...-P10

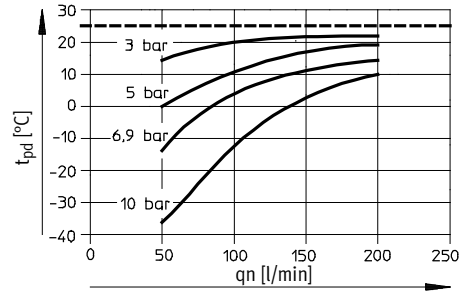

MS6-LDM1-...-P20

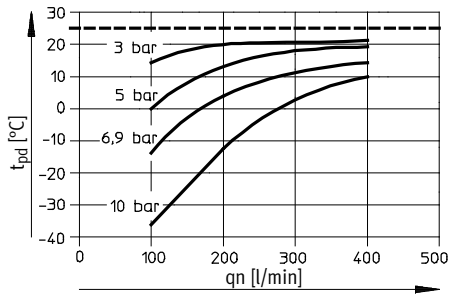

MS6-LDM1-...-P30

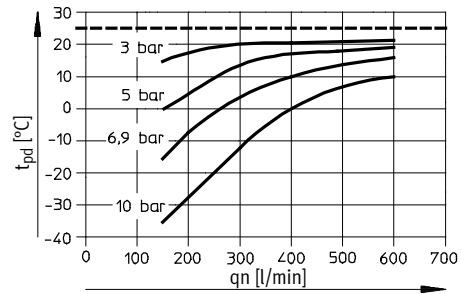

MS6-LDM1-...-P40

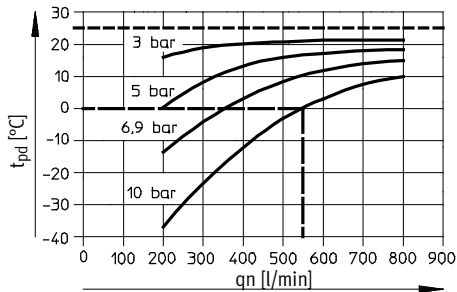

- 1) Measured at pressure dew point t_{pd} (supply) = 25 °C.
- Example MS6-LDM1-...-P40 with 10 bar operating pressure:
the pressure dew point reduction at a nominal flow rate
of $q_n = 550$ l/min is 25 K.

Membrane air dryers MS4/MS6-LDM1, MS series

Technical data

Differential pressure Δp as a function of the standard flow rate at output q_n

MS4-LDM1-...-P05

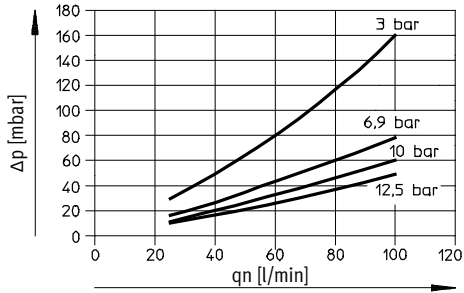

MS4-LDM1-...-P10

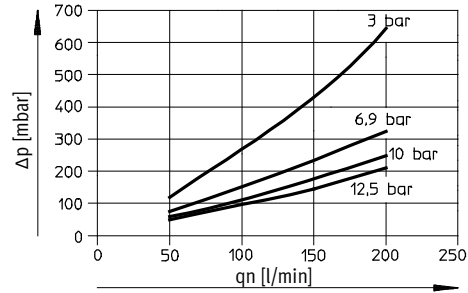

MS6-LDM1-...-P20

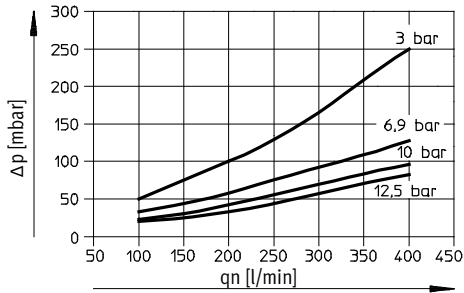

MS6-LDM1-...-P30

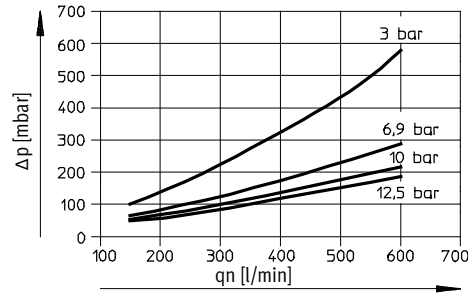

MS6-LDM1-...-P40

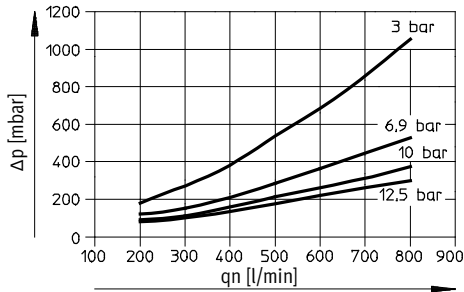

Membrane air dryers MS4/MS6-LDM1, MS series

Technical data

Dimensions

Download CAD data → www.festo.com

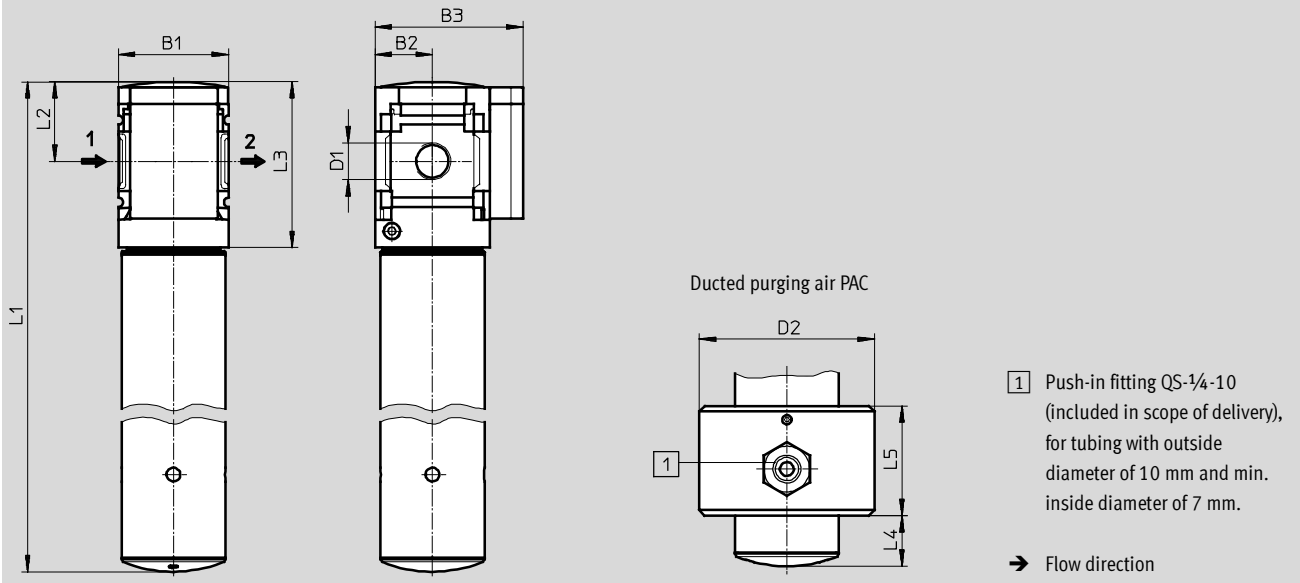

Type	B1	B2	B3	D1	D2	L1	L2	L3	L4	L5
MS4-LDM1-1/8-P05	40	21	54	G1/8	64	245	29	60	18	40
MS4-LDM1-1/8-P10						345				
MS4-LDM1-1/4-P05	40	21	54	G1/4	64	245	29	60	18	40
MS4-LDM1-1/4-P10						345				
MS6-LDM1-1/4-P20	62	31	76	G1/4	80	345	42	87	34	40
MS6-LDM1-1/4-P30						415				
MS6-LDM1-1/4-P40						475				
MS6-LDM1-3/8-P20	62	31	76	G3/8	80	345	42	87	34	40
MS6-LDM1-3/8-P30						415				
MS6-LDM1-3/8-P40						475				
MS6-LDM1-1/2-P20	62	31	76	G1/2	80	345	42	87	34	40
MS6-LDM1-1/2-P30						415				
MS6-LDM1-1/2-P40						475				

Note: This product conforms to ISO 1179-1 and to ISO 228-1

Ordering data

Size	Flow cartridge	Connection	Part No.	Type
MS4	P10	G1/8	543630	MS4-LDM1-1/8-P10
		G1/4	543632	MS4-LDM1-1/4-P10
MS6	P20	G1/4	543640	MS6-LDM1-1/4-P20
		G3/8	543642	MS6-LDM1-3/8-P20
		G1/2	543644	MS6-LDM1-1/2-P20
	P40	G1/4	543646	MS6-LDM1-1/4-P40
		G3/8	543648	MS6-LDM1-3/8-P40
		G1/2	543650	MS6-LDM1-1/2-P40

Membrane air dryers MS4/MS6-LDM1, MS series

Ordering data – Modular products

M Mandatory data					O Options				
Module No.	Series	Size	Function	Pneumatic connection	Flow cartridge	Purging air	Type of mounting	UL certification	Flow direction
543628 543638	MS	4 6	LDM1	1/8, 1/4, 3/8, 1/2 AGA, AGB, AGC, AGD, AGE	P05 P10 P20 P30 P40	PAC	WP WPM WB WBM	UL1	Z
Ordering example									
543628	MS	4	- LDM1	- AGC	- P10	-	- WP	-	-

Ordering table						
Grid dimension	[mm]	40	62	Conditions	Code	Enter code
M	Module No.	543628		543638		
	Series	Standard			MS	MS
	Size	4	6		...	
	Function	Membrane dryer			-LDM1	-LDM1
	Pneumatic connection	Female thread G1/8		-	-1/8	
		Female thread G1/4		Female thread G1/4	-1/4	
		-		Female thread G3/8	-3/8	
		-		Female thread G1/2	-1/2	
		Connecting plate G1/8		-	-AGA	
		Connecting plate G1/4		Connecting plate G1/4	-AGB	
		Connecting plate G3/8		Connecting plate G3/8	-AGC	
		-		Connecting plate G1/2	-AGD	
	Flow cartridge	50 l/min		-	-P05	
		100 l/min		-	-P10	
		-		200 l/min	-P20	
		-		300 l/min	-P30	
		-		400 l/min	-P40	
O	Purging air	Ducted purging air			-PAC	
	Type of mounting	Wall mounting plate		1	-WP	
		Wall mounting plate		1	-WPM	
		Wall mounting bracket			-WB	
		Wall mounting bracket		-	-WBM	
	UL certification	cULus, ordinary location for Canada and USA			-UL1	
	Flow direction	Flow direction from right to left			-Z	

1 WP, WPM Only with connecting plate AGA, AGB, AGC, AGD or AGE.

Transfer order code

	MS		-	LDM1	-		-		-		-		-		-	
--	----	--	---	------	---	--	---	--	---	--	---	--	---	--	---	--